

AIROZON 4500 / AIROZON 4000 S

EN

ORIGINAL INSTRUCTIONS
OZONE GENERATOR



Table of contents

Notes regarding the instructions 2

Safety 2

Information about the device 5

Transport and storage 6

Assembly and start-up 7

Operation 8

Available accessories 11

Errors and faults 12

Maintenance 12

Technical annex 13

Disposal 15

Declaration of conformity 15

Notes regarding the instructions

Symbols

 **Warning of electrical voltage**
This symbol indicates dangers to the life and health of persons due to electrical voltage.

 **Warning**
This signal word indicates a hazard with an average risk level which, if not avoided, can result in serious injury or death.

 **Caution**
This signal word indicates a hazard with a low risk level which, if not avoided, can result in minor or moderate injury.

Note
This signal word indicates important information (e.g. material damage), but does not indicate hazards.

 **Info**
Information marked with this symbol helps you to carry out your tasks quickly and safely.

 **Follow the manual**
Information marked with this symbol indicates that the instructions must be observed.

You can download the current version of the instructions and the EU declaration of conformity via the following link:



Airozon 4500 /
Airozon 4000 S



<https://hub.trotec.com/?id=44525>

Safety

Read this manual carefully before starting or using the device. Always store the manual in the immediate vicinity of the device or its site of use!

 **Warning**
Read all safety warnings and all instructions. Failure to follow the warnings and instructions may result in electric shock, fire and / or serious injury. **Save all warnings and instructions for future reference.**

This appliance can be used by children aged from 8 years and above and persons with reduced physical, sensory or mental capabilities or lack of experience and knowledge if they have been given supervision or instruction concerning use of the appliance in a safe way and understand the hazards involved.
Children shall not play with the appliance. Cleaning and user maintenance shall not be made by children without supervision.

- Do not use the device in potentially explosive rooms.
- Do not use the device in aggressive atmosphere.
- Do not operate the device near open fire or gas appliances.
- Set the device up in an upright and stable position.
- Let the device dry out after a wet clean. Do not operate it when wet.
- Do not use the device with wet or damp hands.
- Do not expose the device to directly squirting water.
- Do not expose the device to liquids as it is not protected against splash water.
- Never insert any objects or limbs into the device.
- Do not cover or transport the device during operation.
- Do not sit on the device.
- This appliance is not a toy! Keep away from children and animals. Do not leave the device unattended during operation.

- Check accessories and connection parts for possible damage prior to every use of the device. Do not use any defective devices or device parts.
- Ensure that all electric cables outside of the device are protected from damage (e.g. caused by animals). Never use the device if electric cables or the power connection are damaged!
- The electrical connection must correspond to the specifications in chapter Technical data.
- Insert the mains plug into a properly secured mains socket.
- Observe the technical data when selecting extensions to the power cable. Completely unroll the extension cable. Avoid electrical overload.
- Before carrying out maintenance, care or repair work on the device, remove the mains plug from the mains socket. Hold onto the mains plug while doing so.
- Switch the device off and disconnect the power cable from the mains socket when the device is not in use.
- Do not under any circumstances use the device if you detect damages on the mains plug or power cable. If the supply cord is damaged, it must be replaced by the manufacturer, its service agent or similarly qualified persons in order to avoid a hazard. Defective power cables pose a serious health risk!
- When positioning the device, observe the minimum distances from walls and other objects as well as the storage and operating conditions specified in the Technical data chapter.
- Make sure that the air inlet and outlet are not obstructed.
- Make sure that there are no loose items or dirt located in the immediate surroundings of air inlet and air outlet.
- Do not expose the device to heat or direct sunlight.
- Never put the device into operation whilst the cover is not completely closed.
- Make sure that the suction side is kept free of dirt and loose objects.

Specific safety warnings for the operation of ozone generators

The device uses ozone for air purification. It is a gas that – due to its oxidative characteristics – can cause severe health damage if inhaled. Direct exposure to and intake of ozone is toxic for humans, animals and plants. For this reason the following safety measures must be observed by all means:

- Once the device has been started as well as during the cleaning process there must be neither people nor animals in the room to be cleaned. Also remove any plants.
- Leave the room immediately once the device has been started.
- After completion of the cleaning process you must wait until the ozone concentration has dropped below a value of 0.2 mg/m³ before entering the room again. Check the present concentration by means of an ozone meter available for purchase from Trotec or in a specialist shop.
- Make sure to seal off all openings of the room to prevent ozone from escaping to the environment.
- Clearly indicate a room's ozone treatment for others and make sure that the room concerned cannot be accessed. Suitable warning signs may be obtained from Trotec.
- Ensure a sufficient supply of fresh air and/or an appropriate air exhaust in the treated rooms once the process has been completed.

Intended use

Only use the device in closed rooms whilst adhering to the technical data and safety instructions.

The device may only be used in the commercial sector and in the industry, especially

- for the professional elimination of odours after fire or water damages,
- for the sterilization of rooms (killing viruses, bacteria, mould and carcinogenic / allergenic microorganisms).

The device may only be used by especially trained expert staff.

Improper use

- Do not use the device as private individual or at home / in a domestic environment.
- Do not place the device on wet or flooded ground.
- Do not place any objects, e.g. clothing, on the device.
- Do not use the device outdoors.
- Any operation other than as described in this manual is prohibited. Non-observance renders all claims for liability and guarantee null and void.
- Any unauthorised modifications, alterations or structural changes to the device are forbidden.

Personnel qualifications

People who use this device must:

- have been trained in handling the device and be aware of the dangers that occur when working with the oxidising agent ozone.
- have read and understood the instructions, especially the Safety chapter.

Residual risks



Warning of electrical voltage

Work on the electrical components must only be carried out by an authorised specialist company!



Warning of electrical voltage

Before any work on the device, remove the mains plug from the mains socket!
Hold onto the mains plug while pulling the power cable out of the mains socket.



Warning

Dangers can occur at the device when it is used by untrained people in an unprofessional or improper way!
Observe the personnel qualifications!



Warning

The device is not a toy and does not belong in the hands of children.



Warning

Risk of suffocation!
Do not leave the packaging lying around. Children may use it as a dangerous toy.



Warning

Risk of injury caused by inhalation of ozone!

The following symptoms could be indicative of poisoning or an irritation caused by ozone:

- eye irritations – conjunctivitis, stinging and watering eyes
- strong urge to cough
- shortness of breath – chest tightness
- pain while inhaling
- dizziness, light-headedness
- headache
- feeling of faintness

Exit the room to be cleaned immediately after the device has been switched on.

Do not enter the room whilst the air purification is in progress.

Should you experience one or more of the above symptoms relating to the use of the odour neutraliser, seek medical treatment immediately!

Note

Do not operate the device without an inserted air filter! Without the air filter, the inside of the device will be heavily contaminated. This could reduce the performance and result in damage to the device.

Note

Do not use abrasive cleaners or solvents to clean the device.

Behaviour in the event of an emergency

1. In an emergency, disconnect the device from the mains feed-in: Hold onto the mains plug while pulling the power cable out of the mains socket.
2. In an emergency only enter the room to be cleaned wearing a gas mask fitted with ozone filter and ensure a sufficient supply of fresh air.
3. Do not reconnect a defective device to the mains.

Information about the device

Device description

Ozone is a very powerful oxidising agent with the ability to eliminate bacteria, viruses, gases and toxins. The oxidising agent ozone breaks down the existing molecules. The ozone is generated by the device in an electrical discharge procedure and emitted to the room air at a high concentration. You can use the device to eliminate e.g. pathogens, but also cooking smells or musty odours as well as burnt smell. The applied method is similar to the natural air purification during a thunderstorm.

Operating principle

The ozone is generated through high-voltage discharge. The high voltage creates extremely high electric field strengths in the discharge unit. This leads to numerous brief barrier discharges between the electrodes.

The integrated fan sucks in ambient air through the air filter at the rear of the device, leads it past the ozone unit and then emits the air that now contains ozone back into the room.

No chemicals are required for the ozone generation, hence this process causes no damage to the environment. When the device has been switched off and the cleaning process has been completed, the remaining ozone in the room air will decompose into normal divalent oxygen (O_2).

Formation, perception and distribution of ozone

The word ozone has become an integral part of our vocabulary and the colourless, toxic gas is part of our everyday life. The irritant effect ozone can have on our eyes and airways has been common knowledge for a few years now, especially since the increasing ozone volume can be attributed to the so-called summer smog. Ozone is further generated during certain industrial processes.

Ozone (chemical symbol: O_3) consists of three oxygen atoms. Ozone is created wherever oxygen molecules (O_2) in the air are turned into atoms (O) due to electrical energy or UV radiation. It is these atoms that can react with the oxygen molecules to form ozone (O_3).

In case of a high solar irradiation ozone forms involving other air pollutants. The nitrogen oxides (NOx) from automobiles, domestic heating systems, power plants and the industry play a major role in this.

Depending on the concentration, ozone can have a very intense smell similar to chlorine, hay or carnations. By nature, the human nose is already vastly superior to most measuring devices: It detects the gas with a concentration of as little as 0.01 ml/m^3 . What this means when compared to other irritant gases is that we humans can already detect even minor quantities of ozone which gives us the opportunity to take corresponding precautions to avoid any hazard caused by the gas in due time. However, our nose also has a crucial disadvantage compared with measuring devices: the so-called

habituation effect. After only a brief period of time spent in an ozone-polluted environment we become so acclimated to the smell that we go noseblind.

The impact of ozone on human beings

The sensitivity to ozone depends on its concentration and varies for each individual. Ozone is an oxidative irritant gas, affecting eyes, nose, pharynx and lungs even at low concentrations. The mucous membranes are unable to stop it seeing as ozone is hardly soluble in water. As a result, the gas can be carried deeper into the lungs than other irritant gases. Concentrations of $200 \mu\text{g}/\text{m}^3$ and higher can cause the following symptoms:

- irritations of the mucous membranes, eyes and the respiratory tract
- hoarseness, coughs and headaches
- feeling of constriction behind the sternum
- reduced physical performance

The main damage is caused in the respiratory tract which can lead to breathing difficulties and a reduced respiratory volume. Late complications can include nosebleeds, a bronchitis (or tracheitis) or a pulmonary oedema. But the transition from irritations without lasting consequences to long-term changes with pathological significance is very smooth.

Ozone threshold and target values

The information threshold for ozone concentrations amounts to $180 \mu\text{g}/\text{m}^3$ (1-hour value) and the alert threshold is $240 \mu\text{g}/\text{m}^3$ (1-hour value). From an ozone concentration of $180 \mu\text{g}/\text{m}^3$ the media starts to inform the public of the recommended behaviour. Furthermore, a target value has been specified to protect human health: Averaged over three years, the daily maximum 8-hour value of $120 \mu\text{g}/\text{m}^3$ must not be exceeded on more than 25 days per calendar year. In the long run, the maximum average values determined over an 8-hour period are not supposed to exceed $120 \mu\text{g}/\text{m}^3$ altogether. To protect the vegetation, a target value of $18,000 \mu\text{g}/\text{m}^3$ applies for a 5-year average. This is the summed up difference between the hourly average values above $80 \mu\text{g}/\text{m}^3$ measured during the daylight hours (8 a.m. to 8 p.m.) in the main growing season between May and July and $80 \mu\text{g}/\text{m}^3$.

Device depiction

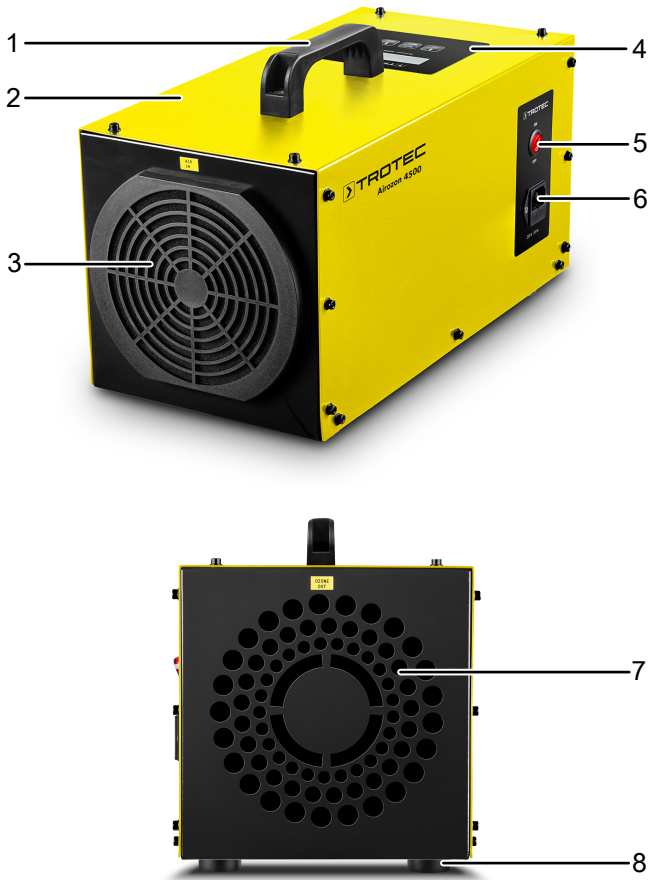

No.	Designation
1	Transport handle
2	Housing
3	Air inlet
4	Control panel
5	On/off switch
6	Power cable connection
7	Air outlet
8	Foot

Transport and storage

Note

If you store or transport the device improperly, the device may be damaged.
 Note the information regarding transport and storage of the device.

Transport

Before transporting the device, observe the following:

- Switch off the device.
- Hold onto the mains plug while pulling the power cable out of the mains socket.
- If the device was previously in use, wait until the end of the calculated regeneration period (see Shutdown chapter) before transporting the device.
- Do not use the power cable to drag the device.
- During transport, protect the device against shifting and vibrations to avoid electrode damage.

After transporting the device, observe the following:

- Set up the device in an upright position after transport.

Storage

When the device is not being used, observe the following storage conditions:

- dry and protected from frost and heat
- with a cover to protect it from invasive dust, if necessary
- stacked on top of one another, if necessary

Assembly and start-up

Scope of delivery

- 1 x Device
- 1 x Manual

Unpacking the device

1. Open the cardboard box and take the device out.
2. Completely remove the packaging.
3. Fully unwind the power cable. Make sure that the power cable is not damaged and that you do not damage it during unwinding.

Start-up

When positioning the device, observe the minimum distance from walls or other objects as described in the Technical data chapter.

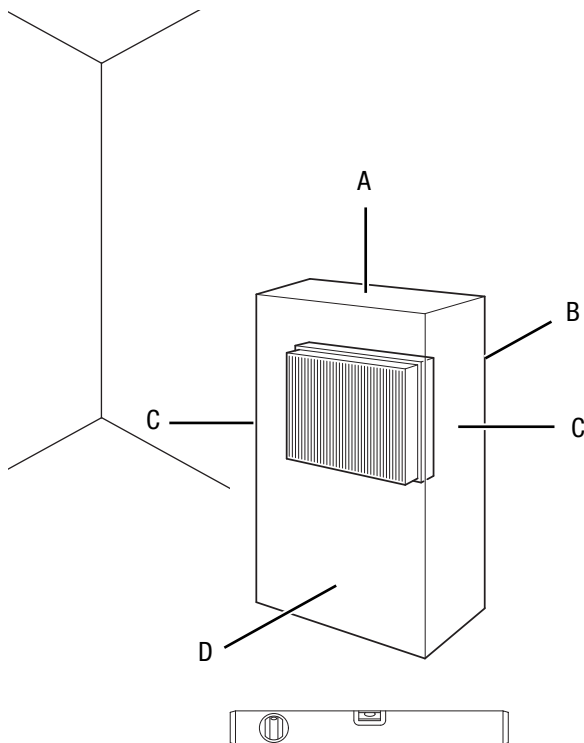

- Position the device as close as possible to the centre of the room to ensure an optimum air circulation.
- When positioning the device, keep a sufficient distance to heat sources.
- Make sure that no curtains or other objects interfere with the air flow.
- Do not position the device near inflammable substances and gases.
- Make sure that the air inlet and outlet are not obstructed.
- Make sure that the device is protected from spray water.
- Do not create tripping hazards when laying the power cable or other electric cables, especially when positioning the device in the middle of the room. Use cable bridges.
- Make sure that extension cables are completely unrolled.
- The room temperature should be approx. 5 °C higher than the usual room temperature.

Connecting the power cable

- Insert the mains plug into a properly secured mains socket located outside of the room to be cleaned. This enables you to switch the device off in case of an emergency without having to access the room.

- Before restarting the device, check the condition of the power cable. If there are doubts as to the sound condition, contact the customer service.
- Set the device up in an upright and stable position.
- Make sure the device is only placed on firm, dry and vibration-free ground.

Operation

Note

Avoid open doors and windows.

Operating elements

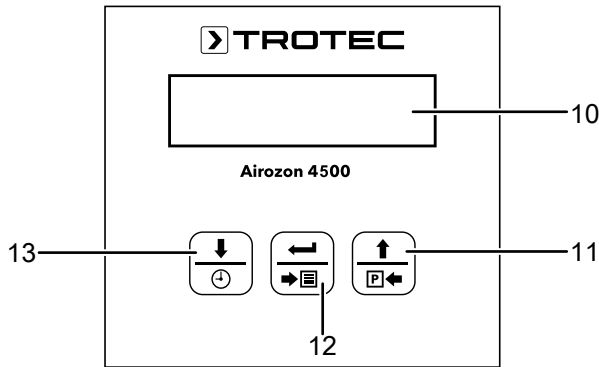
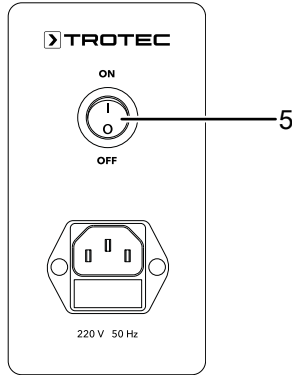

No.	Designation	Meaning
5	On/off switch	For switching the device on or off
10	Segment display	<ul style="list-style-type: none"> • Time and date display • Serial number display • Operating and maintenance time display
11	Increase value / info button	<ul style="list-style-type: none"> • Increase date, time and treatment duration • Exit operating mode selection • Select serial number, operating times and maintenance times
12	Confirm / mode button	<ul style="list-style-type: none"> • Confirm the selected operating mode • Open setup menu
13	Decrease value / time button	<ul style="list-style-type: none"> • Decrease date, time and treatment duration • Select operating mode • Select date and time

Switching the device on



Warning

Risk of injury caused by ozone!

Exit the room as soon as you have switched the device on so as to prevent contact with ozone.

1. Once you have completely installed the device as described in the Start-up chapter, you can switch it on.
2. Set the on/off switch (5) to I and simultaneously press and hold the *Confirm / mode* button (12).
3. Release the *Confirm / mode* button (12) until the menu will be indicated on the segment display (10).
4. Press the *Increase value / info* (11) or *Decrease value / time* button (13) to select the desired operating mode.
 - ⇒ The different operating modes will be described in the following chapters.

Setting the operating mode

- Start/stop mode
- Timing mode
- Real-time mode
- Continuous operating mode

Start/stop mode

In start/stop mode, you can set a switch-on and switch-off time at which the device automatically switches on and off.

- ✓ You have selected the menu for setting the operating mode (see Switching the device on).
- ✓ The selected mode (F = start/stop mode) is indicated on the top left of the display.
 1. Press the *Decrease value / time* button (13) to set a stopping time of maximally 60 minutes.
 2. Press the *Increase value / info* button (11) to set an operating time of maximally 60 minutes.
 3. Press the *Confirm / mode* button (12) to confirm your selection.
 4. Press the *Increase value / info* button (11) to exit the selection.
 - ⇒ The letter R flashes on the display.
 - ⇒ The device is now in start/stop mode.

If you wish to cancel the operating mode, press the *Confirm / mode* button (12).

Start/stop mode screen:

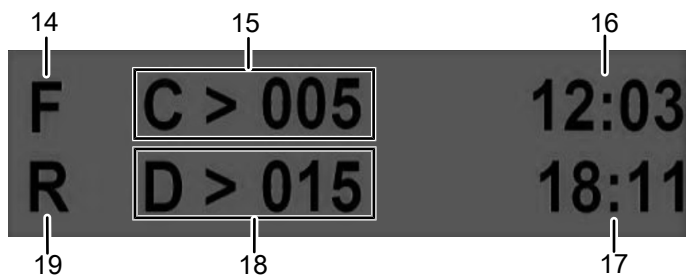

No.	Designation	No.	Designation
14	Selected mode	15	Switch-on time
16	Time	17	Date
18	Operating time	19	Operating condition

Timing mode

In timing mode, the treatment duration can be selected after which the device will automatically switch off.

- ✓ You have selected the menu for setting the operating mode (see Switching the device on).
- ✓ The selected mode (T = timing mode) is indicated on the top left of the display.

1. Use the buttons *Decrease value / time* (13) or *Increase value / info* (11) to set a stopping time of maximally 60 minutes.
2. Press the *Confirm / mode* button (12) to confirm your selection.
3. Press the *Increase value / info* button (11) to exit the selection.
 - ⇒ The letter R flashes on the display.
 - ⇒ The device is now in start/stop mode.

Timing mode screen:

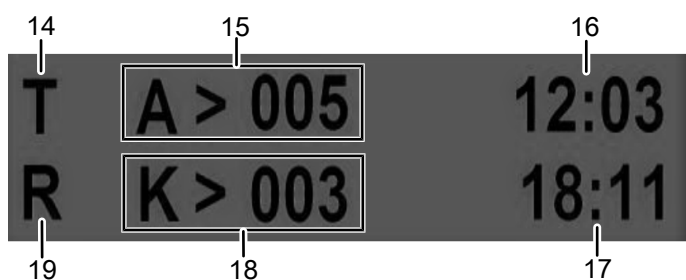

No.	Designation	No.	Designation
14	Selected mode	15	Switch-on time
16	Time	17	Date
18	Operating time	19	Operating condition

If you wish to cancel the operating mode, press the *Confirm / mode* button (12).

Real-time mode

In real-time mode, you can set the real time at which the device automatically switches on and off.

- ✓ You have selected the menu for setting the operating mode (see Switching the device on).
 - ✓ The selected mode (Z = real-time mode) is indicated on the top left of the display.
1. Press the *Decrease value / time* button (13) to open the settings for the switch-on time.
 2. Press the *Increase value / info* button (11) to set a time at which the device will start operating.
 3. Press the *Confirm / mode* button (12) to confirm your settings.
 4. Press the *Decrease value / time* button (13) to open the settings for the switch-off time.
 5. Press the *Increase value / info* button (11) to set a time at which the device will stop operating.
 - ⇒ The letter R flashes on the display.
 - ⇒ The device is now in start/stop mode.

Real-time mode screen:

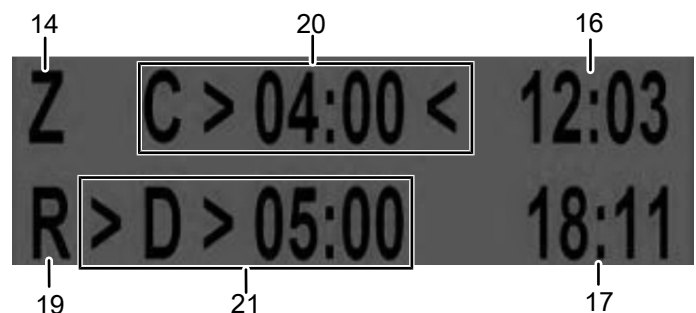

No.	Designation	No.	Designation
14	Selected mode	20	Real-time (switch-on time)
16	Time	17	Date
21	Real-time (switch-off time)	19	Operating condition

If you wish to cancel the operating mode, press the *Confirm / mode* button (12).

Continuous operating mode

In continuous operating mode, the device continues working until it is switched off.

- ✓ You have selected the menu for setting the operating mode (see Switching the device on).
 - ✓ The selected mode (Z = real-time mode) is indicated on the top left of the display.
1. Press the *Confirm / mode* button (12) to switch the device on.
 - ⇒ The letter R flashes on the display.
 - ⇒ The device is now in continuous operating mode.
 - ⇒ The device will keep running until it is switched off.

Carrying out an odour neutralization / air purification



Warning

Risk of injury caused by inhalation of ozone!

The following symptoms could be indicative of poisoning or an irritation caused by ozone:

- eye irritations – conjunctivitis, stinging and watering eyes
- strong urge to cough
- shortness of breath – chest tightness
- pain while inhaling
- dizziness, light-headedness
- headache
- feeling of faintness

Exit the room to be cleaned immediately after the device has been switched on.

Do not enter the room whilst the air purification is in progress.

Should you experience one or more of the above symptoms relating to the use of the odour neutraliser, seek medical treatment immediately!

Please proceed as follows to perform an air purification:

1. Seal off all openings of the room to be cleaned. It must be accomplished in a way to prevent ozone from escaping to the environment.
2. Attach warnings that indicate the presence of high ozone concentrations and the related hazards.
3. Make sure that neither humans nor animals are situated in the room to be cleaned.
4. Position the device in the centre of the room.
5. Connect the power cable and insert the mains plug into a properly secured mains socket located outside of the room to be cleaned.
6. Set the desired treatment duration.
7. Switch the device on and select the desired operating mode.
 - ⇒ The cleaning cycle will probably be launched immediately.
8. Exit the room directly after having started the device.
 - ⇒ The ozone generator will now operate until the end of the set cleaning period. Afterwards it will switch off automatically.

Operating parameters

The duration of the cleaning process can differ depending on the conditions. Factors to be taken into consideration include:

- Type of exposure
- Intensity
- Room size and temperature
- Material composition of the object to be treated
- Exposure time and depth up to which the material has been affected

If an odour elimination is carried out in an unheated room which will later be used at higher temperatures, there is a risk of subsequent evaporation. For this reason the room temperature should always be approx. 5 °C higher during the purification process as compared to the later usage temperature.

The values below are to serve as a general reference for the determination of the treatment duration:

Type of smell	Treatment duration given in min	
	Room size < 30 m ³	Room size 30 – 60 m ³
Disinfectant	30	60
Car treatment	40	80
Animal, cooking and waste smells	40	80
Smell of burning / chemicals	80	120
Musty odour after water damage	80	120
Smell of burning and secondary effects of organic substances	80 – 350	120 – 700
Amines / amides (ureas), open-chain hydrocarbon compounds (e.g. butyric acid)	360	720
Amino acids / proteins with nitrogen and sulphur (vomit)	360	720

Setting the time

1. Set the on/off switch (5) to **I** and simultaneously press and hold the *Decrease value / time* button (13).
2. Release the *Decrease value / time* button (13) until the menu will be indicated on the segment display (10).
3. Press the buttons *Increase value / info* (11) or *Decrease value / time* button (13) to set the real time.
4. Press the *Confirm / mode* button (12) to confirm the real time.

Show device information

1. Set the on/off switch (5) to **I** and simultaneously press and hold the *Increase value / info* button (11).
2. Release the *Increase value / info* button (11) until the menu will be indicated on the segment display (10).
3. Press the buttons *Increase value / info* (11) or *Decrease value / time* button (13) to set the real time.
4. Press the *Increase value / info* button (11) again.
 - ⇒ Information about the device will be displayed.

Device information screen:



Switch-off



Warning

Risk of injury caused by ozone!
Have especially trained staff check the ozone concentration before entering the room and permitting others to access it.

The device was designed to switch off automatically once the set time has elapsed. A corresponding function was integrated by way of a timer.

A certain waiting period must be observed between the device switch-off and accessing the treated room.

Within this safety period the remaining ozone decomposes (naturally) into divalent oxygen (O₂). Afterwards the ozone concentration should have fallen to below the stipulated MAC value (maximum allowable concentration) of 0.2 mg/m³. Ozone has an average half-life of approx. 30 min. You can use the following empirical values as reference for the regeneration:

Operating time	Regeneration period
0.5 hours	0.5 hours
1 hour	0.5 hours
5 hours	2.5 hours

At the end of the waiting period the room must be aired out extensively. Open doors and windows. Take the corresponding protective measures (see Safety chapter).

Shutdown



Warning of electrical voltage

Do not touch the mains plug with wet or damp hands.

1. Switch the device off by setting the on/off switch (5) to position **O**.
2. Hold onto the mains plug while pulling the power cable out of the mains socket.
3. Clean the device according to the Maintenance chapter.
4. Store the device according to the Storage chapter.

Available accessories



Warning

Only use accessories and additional equipment specified in the instructions. Using insertion tools or accessories other than those specified in the instructions may cause a risk of injury.

Designation	Article number
Ozone warning sign	ZZ7000275

Errors and faults

The device has been checked for proper functioning several times during production. If malfunctions occur nonetheless, check the device according to the following list.

The device does not start:

- Check the power connection.
- Check the power cable and mains plug for damages.
- Check the on-site fusing.
- Switch the fuse back on or have a defective fuse replaced by a specialist company.
- Wait for 10 minutes before restarting the device. If the device is not starting, have the electrics checked by a specialist company or by Trotec.

The device is very loud:

- Position the device on a dry, firm and level surface.
- Check whether the fan and its bearing for damage. If you detect any damage, have the device checked by a certified specialist workshop.

The odour nuisance persists after the completed purification process with the same intensity:

- Have the device checked by a certified specialist workshop.

Your device still does not operate correctly after these checks?

Please contact the customer service. If necessary, bring the device to an authorized specialist electrical company or to Trotec for repair.

Maintenance

Activities required before starting maintenance



Warning of electrical voltage

Do not touch the mains plug with wet or damp hands.

- Make sure that the device is switched off.
- Hold onto the mains plug while pulling the power cable out of the mains socket.



Warning

Risk of injury caused by inhalation of ozone!

After the device has stopped operating, wait until the end of the calculated regeneration period (see Shutdown chapter) to make sure that the ozone concentration has fallen below the stipulated value before performing maintenance and cleaning work.

Care and maintenance must be performed on a regular basis to ensure the proper functioning and failure-free operation of the device.

The type and frequency of the maintenance tasks fundamentally depends on the operating environment as well as on the duration and type of use.

In the course of using the device, dust and moisture can accumulate in or on the components which may compromise functionality and efficiency.

In rooms with a high volume of dust and dirt or after fire damage restorations (high moisture level) you should already check the need for maintenance after only a few applications.

In dry surroundings e.g. hotels or as part of car valeting one can assume a maintenance rate of several months.

Criteria for determining the maintenance interval

Device operation takes place:

- frequently and several hours at a time
- on many days per month
- in excessively dirty surroundings
- in humid rooms

Regardless of the described operating conditions you should perform maintenance work if one or more of the following signs become apparent:

- increased noise level during operation of the fan
- heavily contaminated air filter
- dirty electrode (recognizable by: The hissing sound produced during ozone generation dies away.)

Cleaning the housing

Clean the housing with a soft, damp and lint-free cloth. Make sure that no moisture enters the housing. Protect electrical components from moisture. Do not use any aggressive cleaning agents such as cleaning sprays, solvents, alcohol-based or abrasive cleaners to dampen the cloth.

Cleaning

In addition to the inspection of the device and its components for proper condition you should also ensure thorough cleaning as part of the regular maintenance activities. To do so, please proceed as described below.

Cleaning the air filter

1. Remove the cover of the air filter.
2. Remove the air filter.
3. Clean the air filter using soapsuds.
4. Allow the air filter to dry.
5. Reinsert the air filter when dry.

Cleaning the interior

1. Remove the screws at the housing.
2. Remove the housing.
3. Clean the device with compressed air or a damp cloth. Do not use any solvent-containing or aggressive cleaning agents. Make sure that no water can enter or remain inside the housing.
4. Reattach the housing properly.

Technical annex

Technical data

Parameter	Value
Model	Airozon 4500
Article number	1.180.000.108
Electric connection	230 V
Frequency	50 Hz
Max. nominal current	0.5 A
Max. power input	115 W
Ozone output	approx. 4500 mg/h
Air flow rate	approx. 55 m ³ /h
Sound pressure level (at a distance of 3 m)	< 70 dB(A)
Dimensions (depth x width x height)	410 x 210 x 239 mm
Weight	4.5 kg
Minimum distance to walls and other objects:	top (A): 50 cm rear (B): 50 cm sides (C): 50 cm front (D): 50 cm

Overview and list of spare parts

Note: The position numbers of the spare parts differ from those describing the positions of the components mentioned in these instructions.

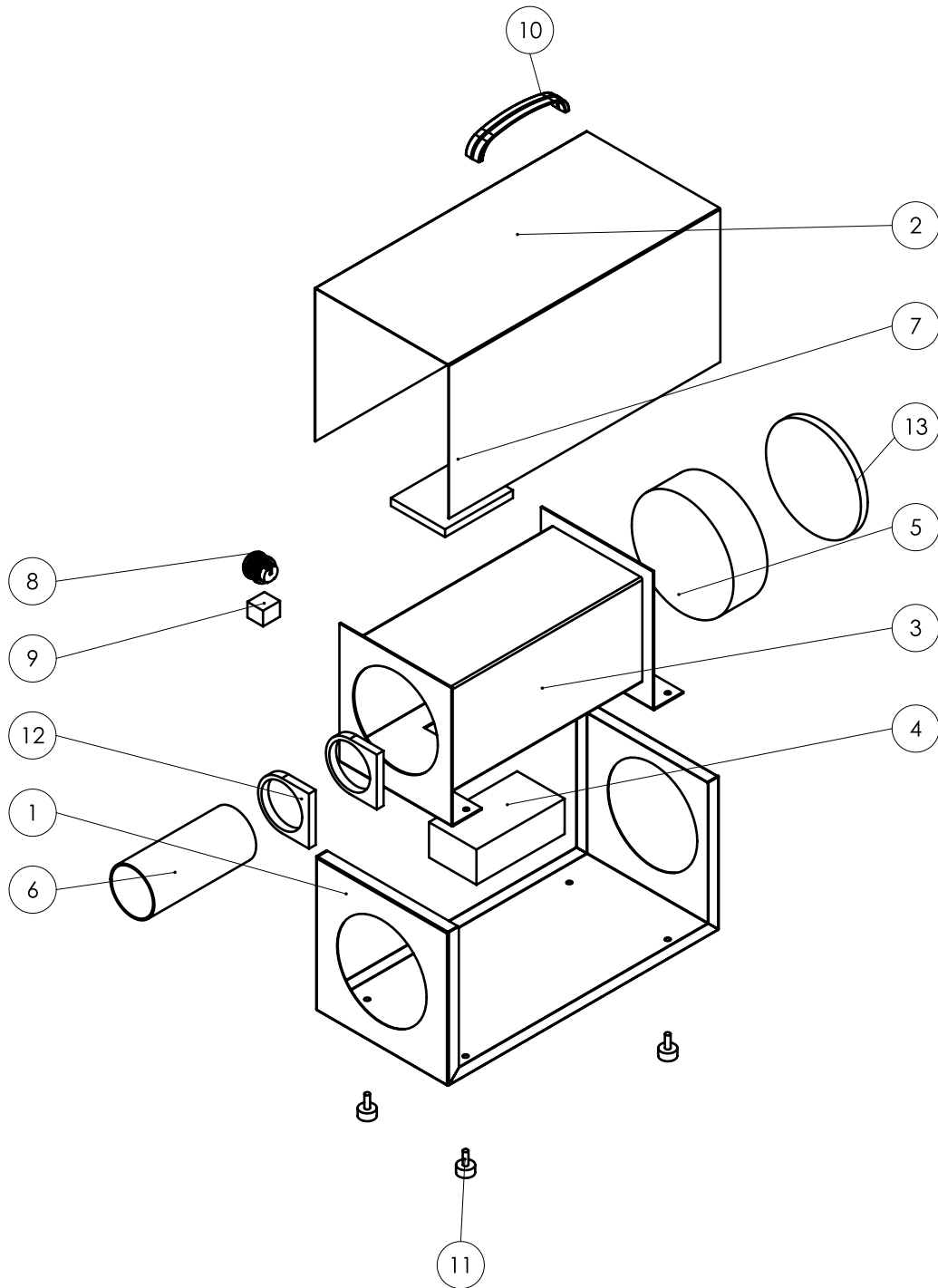

No.	Spare part	No.	Spare part
1	Basic housing	8	Mains switch
2	Housing cover	9	Mains connection
3	Insulation housing	10	Handle
4	High-voltage converter	11	Housing foot
5	Fan	12	Mount
6	Ozone generator	13	Air filter
7	Electronic unit		

Disposal



The icon with the crossed-out waste bin on waste electrical or electronic equipment stipulates that this equipment must not be disposed of with the household waste at the end of its life. You will find collection points for free return of waste electrical and electronic equipment in your vicinity. The addresses can be obtained from your municipality or local administration. For further return options provided by us please refer to our website <https://de.trotec.com/shop/>.

The separate collection of waste electrical and electronic equipment aims to enable the re-use, recycling and other forms of recovery of waste equipment as well as to prevent negative effects for the environment and human health caused by the disposal of hazardous substances potentially contained in the equipment.

Declaration of conformity

The text below sets out the contents of the declaration of conformity. The signed declaration of conformity can be found at <https://hub.trotec.com/?id=44525>.

Declaration of conformity

in accordance with the EC Machinery Directive 2006/42/EC,
Annex II, Part 1, Section A

Herewith, we – Trotec GmbH– declare that the machinery designated below was developed, constructed and produced in compliance with the requirements of the EC Machinery Directive in the version 2006/42/EC.

Product model / Product: Airozon 4500 / Airozon 4000 S

Product type: Ozone generator

Year of manufacture as of: 2020

Relevant EU directives:

Applied harmonised standards:

- EN 60335-1:2012/A11:2014

Applied national standards and technical specifications:

- EN 60204-1:2018

Manufacturer and name of the authorised representative of the technical documentation:

Trotec GmbH
Grebbeener Straße 7, D-52525 Heinsberg
Phone: +49 2452 962-400
E-mail: info@trotec.de

Place and date of issue:

Heinsberg, 22.04.2020

Detlef von der Lieck, Managing Director

Trotec GmbH

Grebener Str. 7
D-52525 Heinsberg

☎ +49 2452 962-400

☎ +49 2452 962-200

✉ info@trotec.com

www.trotec.com